

977 COMMERCIAL GRADE

ROLL UP DOORS

PERFORMANCE • VALUE • SERVICE

Features

- Strong, Heavy-Duty Materials
- Smooth, Quiet Operation
- Custom Sizes
- 977WL Withstands Higher Wind Loads
- Low Maintenance
- Minimal Back Room Requirements
- Commercial Applications
- Motor Operator Applications
- Rust Resistant
- 30/25 Yr Paint
- 3 Yr Material/Craftsmanship
- 10 Yr Spring Warranties



Problem Solved

Trac-Rite's model 977 was designed for performance. With a standard wind rating of 140 mph for 11' wide openings and over 180 mph for a 977WL (windlock), these are seriously strong doors. The doors are loaded with features for long life such as the EP3 coated spring, which resists rust and requires no lubrication. An optional chain hoist system allows for effortless operation for larger door openings, and extra wide felt strips on the back of the door provide smooth operation for decades. A newly redesigned windlock system (977WL) utilizes nylon locks to positively link the door curtain to the guides for greater protection during severe wind events while allowing for easy operation.

Our model 977 door was designed specifically for large door openings where an easy to use, yet cost effective door is required. These doors are the perfect solution for large Boat and RV storage units where a costly sectional door historically has been used. The pre-installed SpaceGuard latch accepts two padlocks and an optional cylinder lock. The doors are available in wide variety of standard colors all at one great price. Our state-of-the art manufacturing provides outstanding quality with a high degree of efficiency.

Trac-Rite takes customer service seriously. We are 100% employee-owned. Every employee has a vested interest in serving our customers. Whether you are interacting with one of our resellers or directly with us, you'll receive prompt responses and knowledgeable assistance.

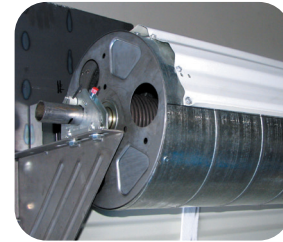

Dead-axle design with torque-tube assembly allows the door to operate with ease.

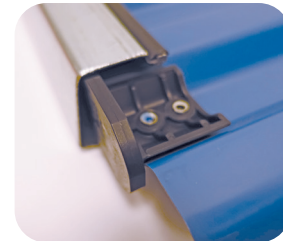

As wind blows against the 977WL, the curtain's windlocks engage with the door guide for a strong interlocking grip. This grip keeps the curtain securely in the guide.



Saddle with tensioner device makes adjusting the door tension easier, safer, and quicker than clamp and bracket designs.



Chain hoist mounts below bracket for space-saving installation. 8:1 reduced-drive allows for smooth operation.



The SpaceGuard latch design resists wrenching and prying for superior security and safety. An additional safeguard is the anti-padlock open feature. Accommodates Trac-Rite's optional SpaceGuard cylinder lock for over-locking capability.



Colors vary from actual panel material. Please request a steel color sample for precise shade at 800.448.8979

977

ROLL UP DOORS



**977 & 977WL
ROLL UP DOORS**

Specifications

DESIGN TYPE Dead-axle design with torque-tube assembly. Rotates on a fixed axle during operation.

TORQUE-TUBE ASSEMBLY Axle is high-yield structural tubing with 1-5/16" outside diameter. Drums are 12" diameter spiral x 1-1/2" wide, 16-gauge, zinc-coated steel with grease-filled ball bearings mounted in the center of the drum to promote smooth operation. Springs are helical torsion, oil tempered, and coated to halt corrosion. Axle, drums, and springs are enclosed in a 26-gauge galvanized spiral tube to provide even curtain support.

CURTAIN Roll-formed sections, factory seamed from 26-gauge, Grade 80 galvanized steel. Siliconized polyester finish in sixteen standard colors. Full-length 2" felt tape for smooth rolling and reduced marring.

BOTTOM ASSEMBLY Seal-Rite pliable bulb and blade astragal integrated into galvalume bottom bar with stiffening angle.

BRACKETS Universal mounting brackets are interchangeable for mounting on the left or right side. 10-gauge, cold-formed, galvanized steel, embossed for added strength.

SADDLE WITH TENSIONER Easily adjustable one-piece saddle accepts 1-5/16" diameter axle. Double cams lock the axle in position and maintain tension on the springs.

GUIDES Zinc-coated, 2-3/4" deep. Featuring polypropylene guide runners to assure smooth operation and prevent steel-on-steel contact.

977WL CURTAIN WINDLOCKS Black nylon 6/6 secured to door with two 3/16" stainless steel rivets.

CHAIN HOIST 8:1 reduced-drive. Mounts directly to the axle on either the left or right side.

EXTERIOR LATCHES Rust-resistant cast zinc alloy with black nickel finish. Latch bar, embossed for strength, is compatible with magnetic security systems. Designed to accommodate two padlocks up to 7/16" shank. Accommodates Trac-Rite's optional SpaceGuard cylinder lock for easy over-locking.

MOUNTING FASTENERS Steel or wood fasteners included. For masonry openings, mounting clips and anchoring system are sold separately.

DOOR STOP 12-gauge, zinc-coated, L-shaped door stops. Mount to guides.

PULL ROPE HANDLE Molded plastic rope handle with long-lasting rope.

Product specifications are subject to change without notice.

Mounting Surface & Door Clearance Requirements

Measure the following areas to design a 977 or 977WL door to your specific needs.

Framed Opening

Measure the framed opening.

A = Width

B = Height

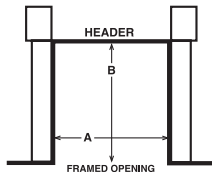

The 977 and 977WL doors are available in custom sizes from 8'W x 8'H to 14'W x 16'H in 1" increments.

FOR EXAMPLE: If your framed opening is 14'6" wide and 16'0" high, you would order a 14'6" x 16'0" (width first, height second) door.

Mounting Surfaces

Measure the mounting surface areas.

NOTE: All mounting surfaces must be flush.

C = Width for Chain Hoist 7"*

* Axle must be field cut.

C = Width for No Hoist 4-1/2"

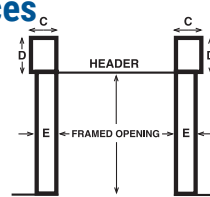

Minimum Mounting Surface Areas

Your Measurement

Brackets

C = Width

4.5"

' "

D = Height

13"

' "

Guides

E = Width 3" (5" masonry jamba)

' "

Door Clearance

Measure the door clearance.

NOTE: Insulated doors require an additional 1" of back room and head room.

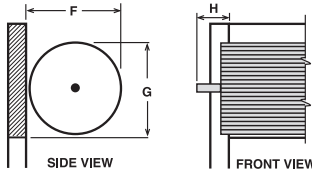

Minimum Clearance
977 = 20" / 977WL = 21"

Your Measurement

F = Back Room

977 = 22" / 977WL = 23"

' "

G = Head Room

977 / 977WL = 7" and 4-1/2"

' "

H = Side Room

Wind Load Ratings

Tested and certified by an independent lab.

Door Width	977 PSF / MPH	977WL PSF / MPH
8'0"	-24.8 / 180	-42.0 / 234
9'0"	-22.0 / 170	-37.3 / 222
10'0"	-17.6 / 153	-32.0 / 206
11'0"	-16.0 / 146	-29.1 / 197
12'0"	-12.0 / 127	-26.7 / 189
13'0"	n/a	-24.2 / 181
14'0"	n/a	-21.8 / 172

Exposure based on Category B.

*MPH rating represents wind speed per the International Building Code (IBC), Exposure B. Actual allowable wind speed may vary based on actual site conditions and application.

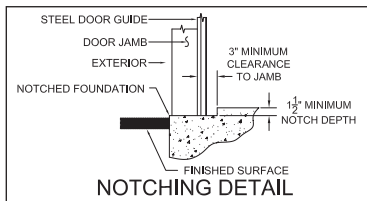

Floor offset recommended to prevent water migration.

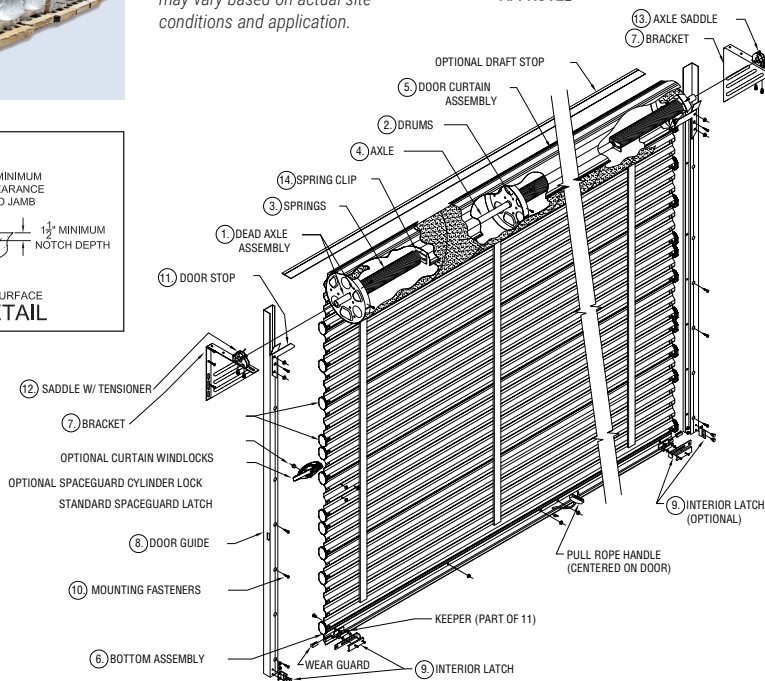

For more information

PHONE 800.448.8979
 FAX 800.236.8722
 WEBSITE www.tracrite.com
 EMAIL tr@tracrite.com
 ADDRESS 314 Wilburn Road
 Sun Prairie, WI 53590